

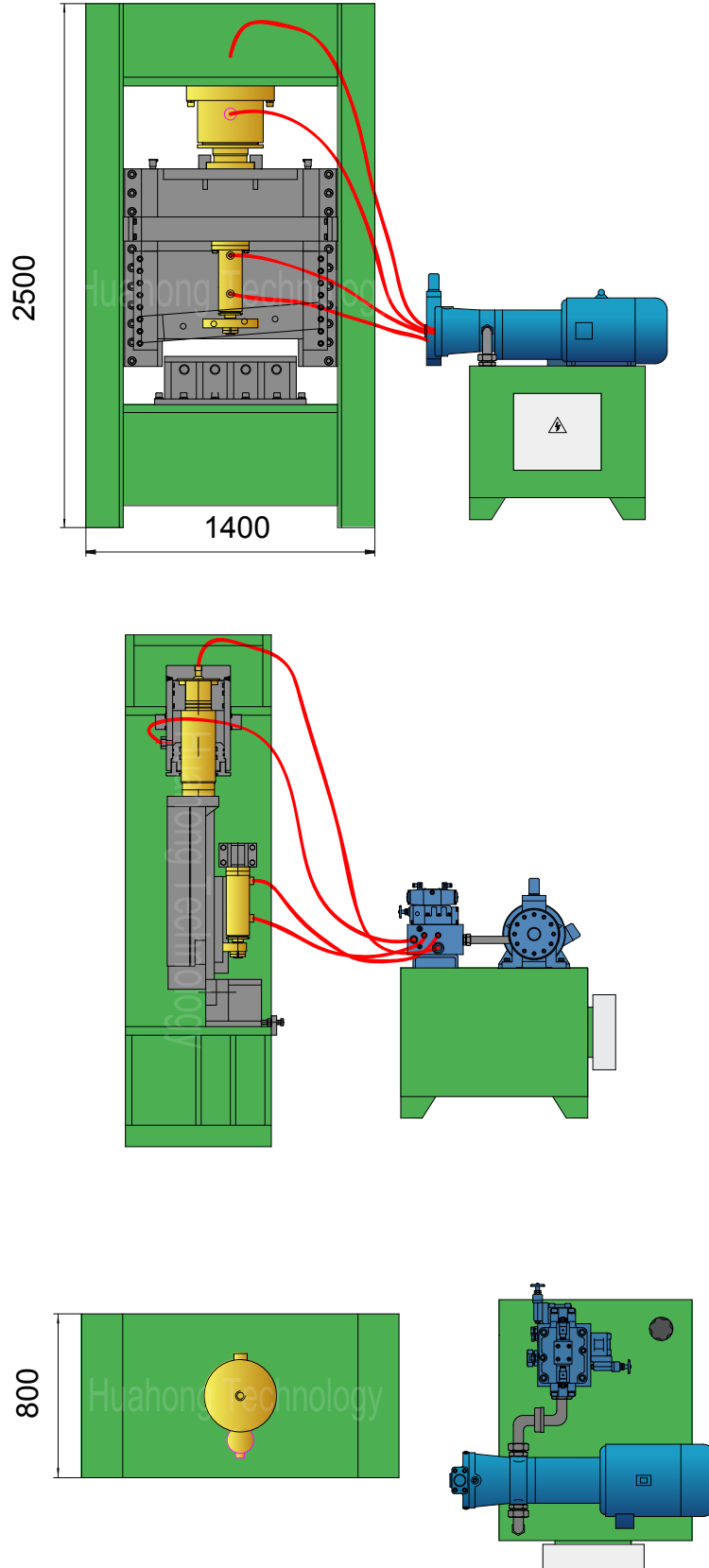

Q15A-200 I

Plan View





Q15A-200 I

Technical parameters

Hydraulic Shear (Square Shear)

Model: Q15A-200 I

Power System (Motor)

Type:	Y200L2-6
Rated Power:	22 kW
Rated Speed:	970 rpm
Power Spec:	3PH, 50 / 60Hz

System Parameters

Max. Shearing Force:	200 Ton
Max. Pressing Force:	12.5 Ton
Hydraulic System Pressure:	25 MPa
Cutting Speed:	4-7 times/min

Hydraulic System (Pump)

Type:	160YCY14-1B
Rated Displacement:	160 ml/r
Max Operating Pressure:	31.5 MPa

Optional Configuration

NOK (JAPAN) Seal Packings for Cylinders;
Cooler / Heater;
Magnetic Oil Filter;
Diesel / Diesel Generator for Power.

Operation System

Hydro-electrical Valves, Push Button Control.

General Description

Main Machine Size (L×W×H):	1400×800×2500 mm
Height of Working Table:	780 mm
Blade Length:	600 mm
Blade Angle:	4.5 Degree
Shear Opening:	100 mm
Max. Cutting Size (Steel Sheet):	25×500 mm
Shipping Weight:	Approx. 5.5 tons
Loading (Standard Containers):	1/2×20'GP

Hydraulic Oil Brand

Oil Tank Volume: 1400 ltr

ISO VG	China	U.S.		Britain	France
	GB11118.1	CALTEX CO.	MOBIL	SHELL	ELF CO.
HM 46	46 #	Rando HD46	D.T.E46	Tellus 46	Elfolna 46
HM 68	68 #	Rando HD68	D.T.E68	Tellus 68	Elfolna 68

Above information are indicative not engaging. Rights reserved for change if necessary.